

ADVANTEST[®]

Spectrum Analyzers

U3741/3751

Compact Design with High Performance

Pioneering 3 GHz/8 GHz Spectrum Analyzers are Now Available!



The U3741/3751 portable spectrum analyzer supports a great range of applications, from use on production lines to system installation and maintenance. Its digital IF enables dramatic improvements in power measurement accuracy for digitally modulated signals. Moreover, the U3741/3751 provides twice the throughput of its predecessor. A light and compact 3 GHz/8 GHz spectrum analyzer, the U3741/3751 provides basic performance reliably and at a low cost.

- Better measuring speed due to high-speed processing (twice as fast as its predecessor)
- Dramatically improved power measurement accuracy for digitally modulated signals
- Built-in 3 GHz/8 GHz pre-amp standard
- Average display noise level:
 - 155 dBm/Hz@1 GHz, pre-amp ON
- Tracking generator covering a frequency range of 100 kHz to 3 GHz
- Option available for measurement of phase noise characteristics
- Lightweight and compact design, with a maximum weight of only 5.6 kg
- Continuous operation of up to 2.5 hours with the battery pack



Compact, Quality, and

U3741/3751 Web Demonstration

Please access to the <http://www.advantest.co.jp/en-index.shtml> and click on the following links.

PRODUCTS & SUPPORT

Electronic Measuring Instruments

Products

U3751

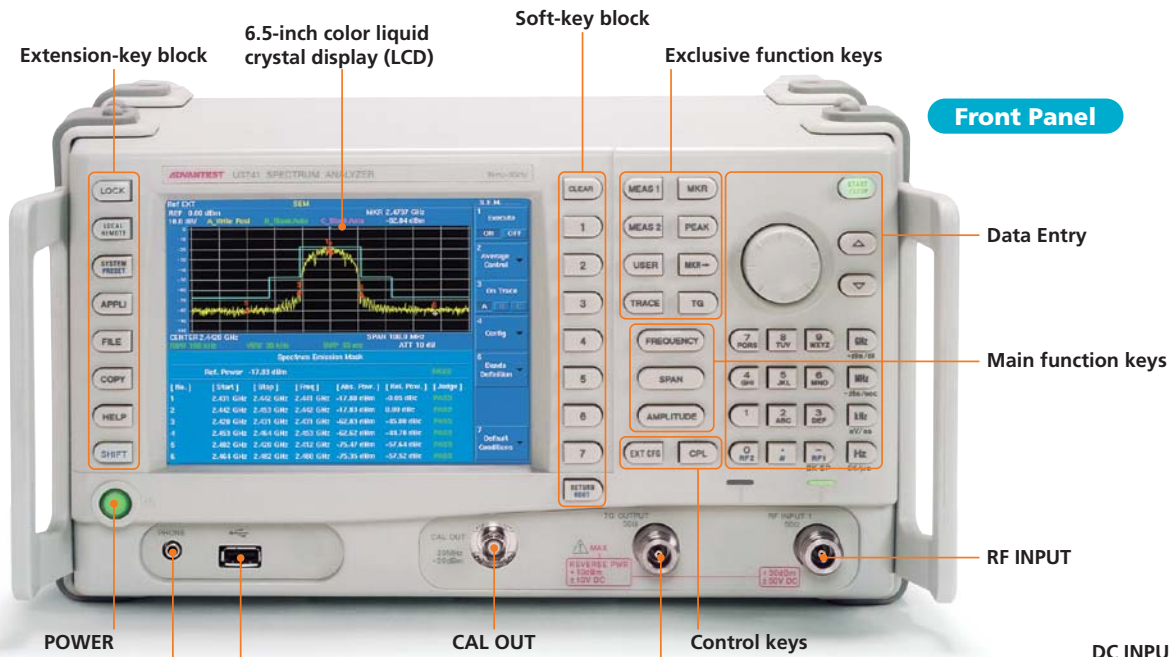

POWER
Earphone jack for demodulated AM/FM audio

PHONE
Earphone jack for demodulated AM/FM audio

USB
Output file data to USB memory or a USB printer
Image files: PNG, BMP
Setting files: BIN, XML

CAL OUT

TG OUT
Tracking generator (option)

Control keys

Battery mount
Mount for the battery pack (battery sold separately)

DC INPUT
Operation with an external DC power supply
+11 VDC to +17 VDC

Mobility

Rear Panel

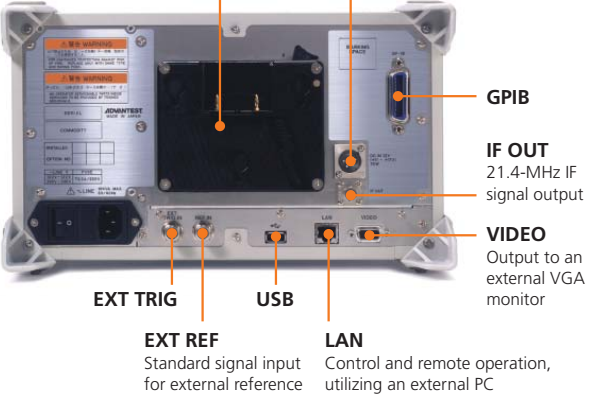

EXT TRIG

EXT REF
Standard signal input for external reference

USB

LAN
Control and remote operation, utilizing an external PC

Option Guide

Product name	Model number	Overview	Main unit support	
			U3741 (9 kHz to 3 GHz)	U3751 (9 kHz to 8 GHz)
75 Ω Input Impedance	OPT.15	Used for measurement of CATV and TV signals	●	—
High-Stability Frequency Reference Source	OPT.20	High-stability reference oscillator with an aging rate of $\pm 2 \times 10^{-6}/\text{day}$, $\pm 1 \times 10^{-7}/\text{year}$	●	●
EMC Filter	OPT.28	CISPR bandwidths are available for EMI measurement. RBW (6 dB down): 200 Hz, 9 kHz, 120 kHz, 1 MHz	● ¹⁾	● ¹⁾
High-Purity Spectrum Analysis	OPT.70	High-purity spectrum analysis with -102 dBc/Hz @ 10 kHz offset (Typical) RBW 30 Hz has also been added.	● ¹⁾	● ¹⁾
75 Ω Tracking Generator	OPT.75	Used for evaluation of frequency characteristics in a range from 100 kHz to 2.2 GHz. Output power range: 107 to 47 dBμV	● ²⁾	—
50 Ω Tracking Generator	OPT.76	Used for evaluation of frequency characteristics in a range from 100 kHz to 3 GHz. Output power range: 0 to -60 dBm	● ¹⁾	● ¹⁾

1) OPT.15 and OPT.75 cannot be installed simultaneously. 2) OPT.15 is required, and cannot be installed simultaneously with OPT.76.

Compact Design with High Performance

5-minute warm-up time

With the U3741/3751, warm-up time has been reduced to a scant 5 minutes (at an ambient temperature of 20 to 30°C). This shortened period virtually eliminates pre-warming time as a consideration, and permits quick and accurate measurement.

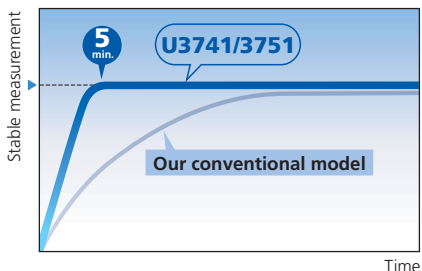

High throughput

This spectrum analyzer delivers data transfer speed superior to that of its predecessor. While the previous model delivered 875 ms, the U3741/3751 boasts a speed of 350 ms: double the system throughput² (using the GPIB interface)³. This faster speed contributes to a significant reduction in cost of test on production lines and in similar applications.

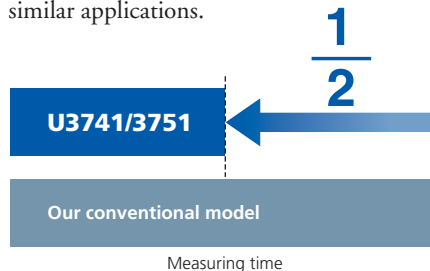

Improvements in overall accuracy

Digitized IF sections and innovative circuit technology dramatically improve absolute power measurement accuracy.

±0.8 dB (10 MHz to 3 GHz: U3741/3751)

±1.0 dB (3 to 8 GHz: U3751)

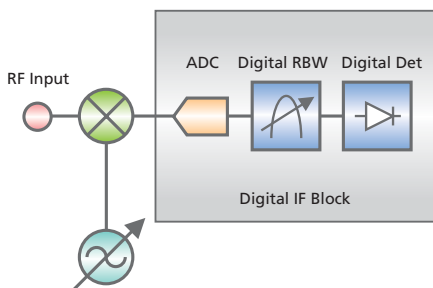

Standard USB (1.1) interface

Screenshots in BMP or PNG format can easily be sent via USB external memory. Users can easily store data, and easily paste measurement data into reports.



Up to 2.5 hours^{*1} of nonstop battery-driven operation

The spectrum analyzer uses one of three power systems: AC (100 V/200 V), DC (+11 V to +17 V), or the battery pack. This flexibility enables measurement in a variety of applications, whether in the factory or in the field.



Compact design

At about half the size of its predecessor, this spectrum analyzer offers a compact design while maintaining the same level of functionality. Its form factor gives it portability, enabling it to be used anywhere.



*1: Typical value at room temperature, without options

*2: Twice that of its predecessor

*3: Sample case where the frequency and span are specified, and the channel power measurement result is transferred

Extensive array of measurement functions

Measurement functions include Channel Power, Total Power, Avg Power, OBW, ACP, Spurious measurement, Harmonics measurement, IM measurement, Noise/Hz calculation functions, multi-marker (10 markers), delta marker, peak marker functions, a channel setting function, and a 3-trace simultaneous sampling function.

Measurement Functions

RMS Average, essential for power measurement

Power tends to be spread over a wide frequency range, and the peak factor tends to be higher in digital modulation, with its expanded communication capacity. The U3741/3751 allows precise power measurements by determining the effective values (RMS values) from instantaneous power values obtained in high-speed sampling and translating them into a power spectrum. This method also enables measurement reproducibility of 0.01 dB in power measurement of digitally modulated signals.

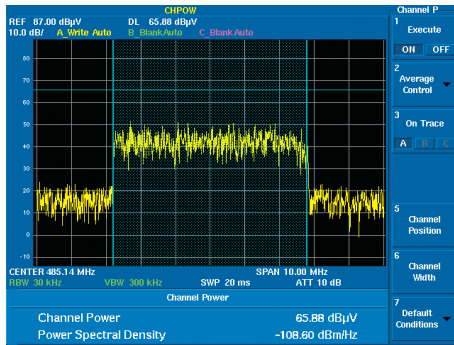

Example of ISDB-T Channel Power measurement

Pre-Amp covering the 3 GHz/8 GHz bandwidth

The U3741/3751 contains as standard a pre-amp that covers all frequency bands. In the analysis of faint signals, its input sensitivity can be equivalent to that of high-end models. Also, it effectively compensates for the loss from the antenna when measuring radio signals in an outdoor environment.

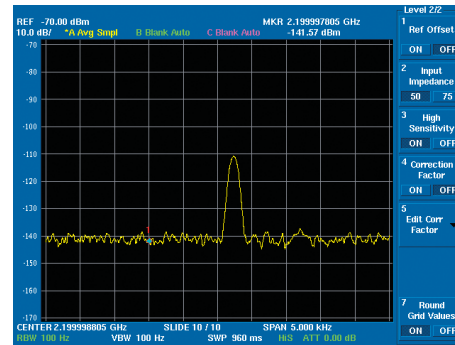

Example of high-sensitivity measurement in high-sensitivity mode

Built-in frequency counter with 1-Hz resolution

Frequency can be accurately measured by simply positioning the cursor on the target spectrum selected from multiple spectral lines. The U3741/3751 is indispensable for measuring the carrier wave frequency in a general multi-carrier system.

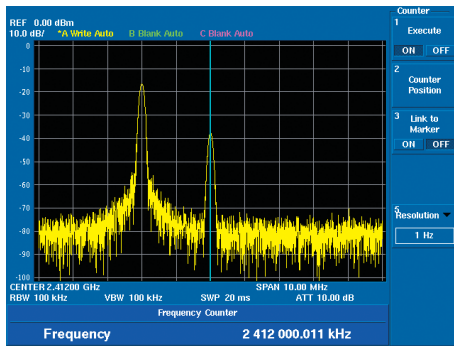

Example of multi-carrier signal frequency measurement

USER keys

An arbitrary key can be selected from the hierarchical function keys and assigned to a USER function. Users can thus configure their own, original setup for operations by assigning frequently used functions to specific software keys.

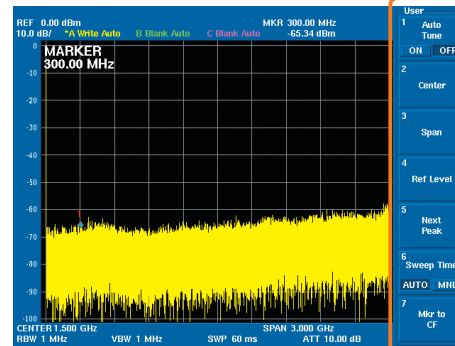

Example of user function assignment

Zoom function

The measuring window and F-F mode can facilitate analysis of a specific signal in broadband measurement. Also, RBW can be changed independently, enabling high-speed measurement of the target signal in both broadband and narrowband. A variety of other signal analysis functions are also available, including those in F-T mode or T-T mode.

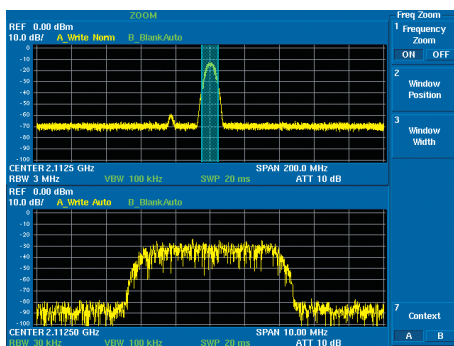

Example of two-screen sample from measurement in broadband and narrowband

Spectrum emission mask function

Using tools such as a spectrum mask and limit line to judge PASS/FAIL is effective at improving production line throughput for digital appliances. Using the spectrum emission mask (SEM) function can facilitate measurement for standards such as wireless LAN.

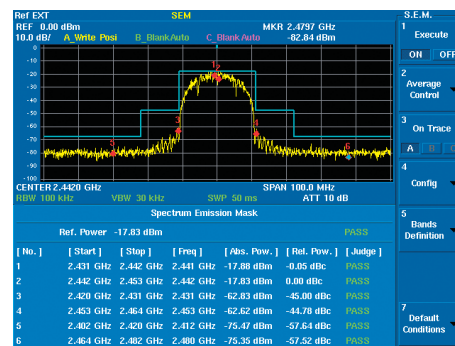

Example of S.E.M. measurement for wireless LAN

User-friendly and Convenient Functions

Gated Sweep function

A radar or TDMA communication system controls its output transmission by turning the power on/off intermittently. To monitor the power spectrum during transmission, the Gated Sweep function is effective at analyzing the spectrum only when the signal is present and over only the area chosen. This function also includes an IF trigger that does not require synchronized signals.

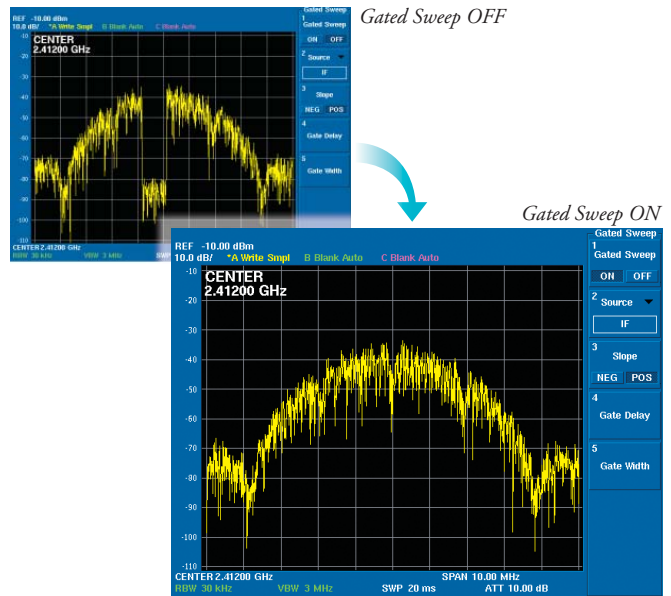

Ideal for remote operation/monitoring via a LAN

This spectrum analyzer is equipped with a 10/100BASE-T LAN port as standard, so it can be operated remotely from an external PC. It can be installed in an unattended radio transmission station, and remotely operated and monitored from another station.

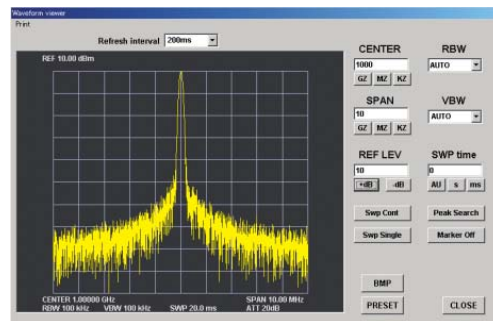
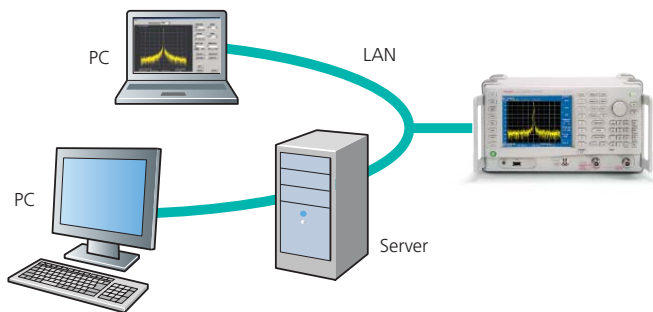

Screen of remote operation/monitoring from an external PC via LAN

Searching for the location of a fault in a coaxial cable

When used with its tracking generator option and the sample software for an external PC, the U3741/3751 can measure the distance to the failure point (open/short) in a coaxial cable. This application permits this distance to be measured from one end of the coaxial cable.

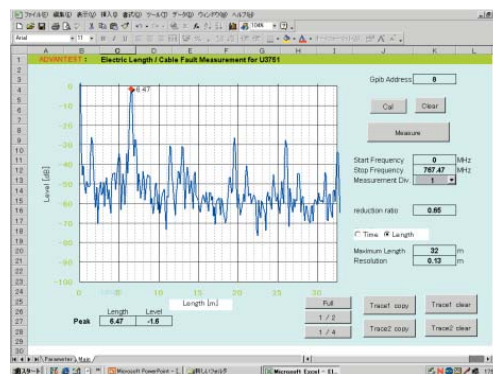
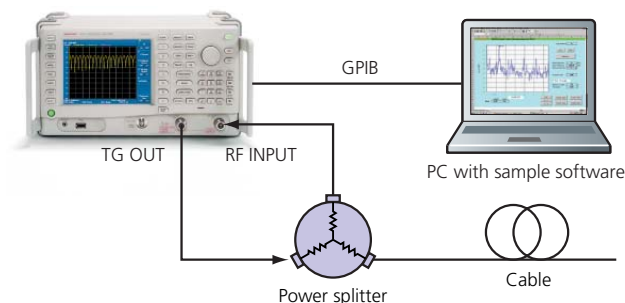

Screen for measuring the distance to a cable failure point

Extensive Array of Options

High-Purity Spectrum Analysis OPT.70

Phase noise measurement is indispensable to evaluation of the characteristics of high-frequency oscillation circuits or modules. The high-purity spectrum analysis option offered with the U3741/3751 can improve the phase noise measurement performance of the spectrum analyzer. Because the performance can be selected, selecting the most suitable spectrum analyzer for the device under test (DUT) is simple. At the same time, the added resolution bandwidth of 30 Hz enables reduction of the display average noise level and analysis in a high dynamic range.

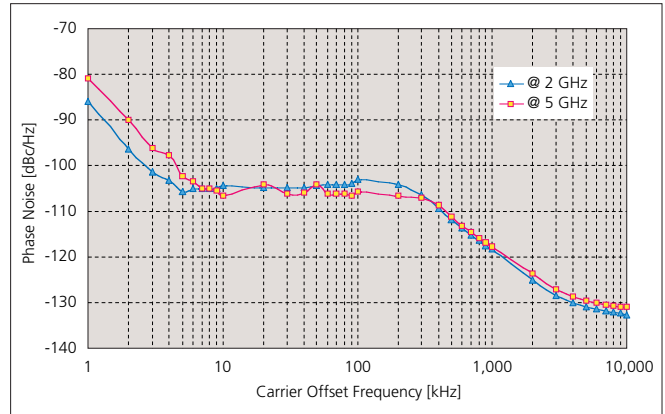

Phase noise characteristic graph (representative values)

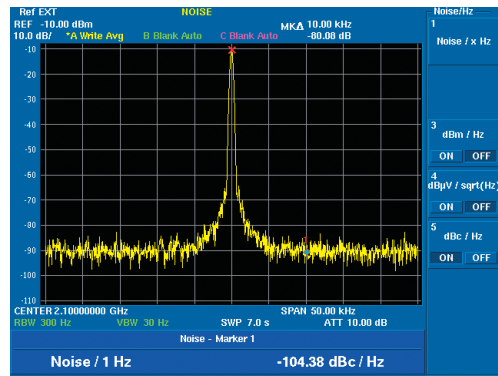

Example of phase noise measurement

EMC Filter OPT.28

Option 28 adds 6 dB RBW CISPR bandwidths for EMI measurement of 200 Hz, 9 kHz, 120 kHz, and 1 MHz. A broadband sweep by the spectrum analyzer is very effective at measuring noise emitted from electrical devices. Installing OPT.28 allows measurement in CISPR-specified bandwidths. It enables simple, fast measurement using the Positive peak detector and Max Hold, which makes it effective at compensating for emitted noise. It guarantees an impulse bandwidth accuracy of 1 MHz. This capability conforms to the standard for noise measurement of 1 GHz or above.

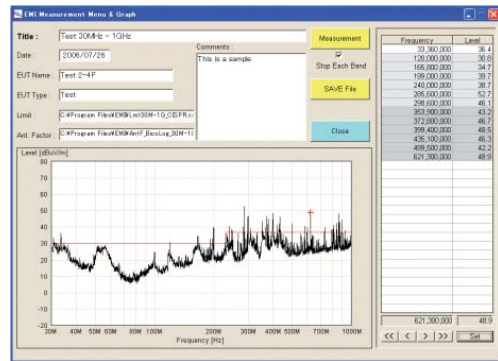

Example of measurement using EMI sample software

Extensive Array of Options and Accessories

Tracking Generator OPT.75/76

Generates synchronized signals for frequency sweeps by the spectrum analyzer.

- OPT.75 Output impedance: 75 Ω
Output frequency range: 100 kHz to 2.2 GHz
- OPT.76 Output impedance: 50 Ω
Output frequency range: 100 kHz to 3 GHz

Functions for evaluating frequency characteristics

The normalize function enables direct measurement of cable loss and filter characteristics. The frequency offset function of the tracking generator enables measurement of frequency characteristics and conversion loss characteristics of mixers and other frequency conversion devices.

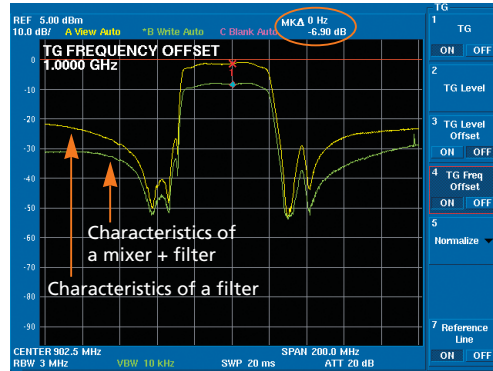
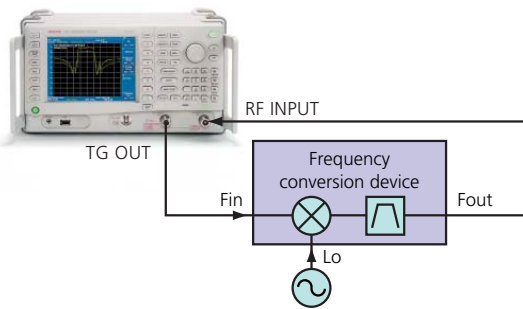

Example of measurement of mixer frequency conversion loss characteristics

Function for return loss measurement

The SWR bridge can be used to measure reflection characteristics of an antenna or filter. It can determine the return loss and evaluate the VSWR.

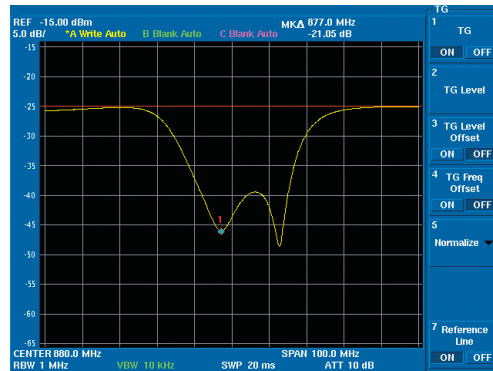
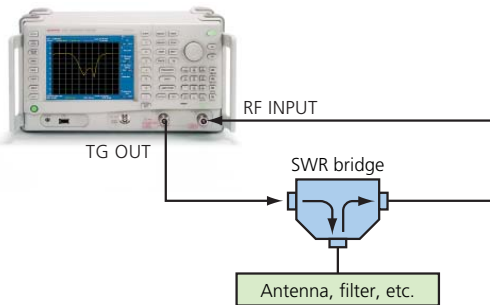

Example of filter return loss measurement

Accessories

Many accessories are available, including an easy-to-carry transit case and a battery pack, useful for field work.



Specifications	
Frequency	
Frequency range	
U3741:	9 kHz to 3 GHz, 9 kHz to 2.2 GHz (with the OPT.15 installed)
Pre-Amp:	10 MHz to 3 GHz, 10 MHz to 2.2 GHz (with the OPT.15 installed)
Synchronizable frequency range:	9 kHz to 3 GHz
U3751:	9 kHz to 8 GHz
Frequency band:	9 kHz to 3.1 GHz (band 0), 3 GHz to 8 GHz (band 1)
Pre-Amp:	10 MHz to 8 GHz
Frequency reading accuracy:	± (marker read value x frequency reference accuracy + span x span accuracy + residual FM)
Frequency reference stability	
Aging rate:	±2 x 10 ⁻⁶ /year
Temperature stability:	±2.5 x 10 ⁻⁶ (0 to 50°C)
Frequency counter:	At a signal level S/N > 50 dB
Resolution:	1 Hz to 1 kHz
Accuracy:	± (counter read value x frequency reference accuracy + residual FM + 1 LSB)
Frequency stability	
Residual FM (zero/span):	< 60 Hzp-p/100 ms (internal frequency reference)
Frequency span	
Range:	5 kHz to Full, zero span 1 kHz to Full, zero span (with the OPT.70 installed)
Accuracy:	< ±1%
Spectrum purity:	-85 dBc/Hz (offset 10 kHz, span < 200 kHz)
Resolution bandwidth	
Range:	
U3741:	100 Hz to 1 MHz (1 to 3 steps) 30 Hz to 1 MHz (with the OPT.70 installed)
U3751:	100 Hz to 3 MHz (1 to 3 steps) 30 Hz to 3 MHz (with the OPT.70 installed)
Accuracy:	< ±12%
Video bandwidth range:	10 Hz to 3 MHz (1 to 3 steps)
Sweep	
Sweep time	
Setting range:	20 ms to 1000 s (spectrum mode) 50 μs to 1000 s (zero span)
Accuracy:	< ±2% (zero span)
Sweep mode:	Continuous, single, gated
Trigger function	
Trigger source:	Free run, video, external, IF
Amplitude range	
Measurement range:	Noise level to +30 dBm Noise level to 134 dBμV (with the OPT.15 installed)
Maximum safe input level:	Attenuator ≥ 10 dB
Pre-Amp OFF:	+30 dBm, 134 dBμV (with the OPT.15 installed)
Pre-Amp ON:	+13 dBm, 120 dBμV (with the OPT.15 installed)
U3741:	±50 VDC max.
U3751:	±15 VDC max.
Input attenuator range:	0 to 50 dB (10 dB steps)
Display range:	100/50/20/10/5 dB, linear
Scale unit:	dBm, dBmV, dBμV, dBμVemf, dBpW, W, V
Reference level setting range:	-140 to +40 dBm -31.2 to 148.8 dBμV (with the OPT.15 installed)
Detection mode:	Normal, Positive peak, Negative peak, Sample, RMS, and Average

Amplitude accuracy	
Calibration signal	
Frequency:	20 MHz
Level:	-20 dBm (75 Ω, with the OPT.15 installed)
Accuracy:	±0.3 dB, ±0.4 dB (with the OPT.15 installed)
Scale display accuracy	
Log:	±0.5 dB/10 dB, ±0.5 dB/80 dB, ±0.2 dB/1 dB
Overall amplitude accuracy:	After calibration, with the pre-amp OFF, and at a temperature ranging from 20 to 30°C Input attenuator 10 dB Reference level 0 dBm, input signal level -10 to -50 dBm ±1.0 dB (9 kHz to 3 GHz) ±0.8 dB (10 MHz to 3 GHz)
U3741:	Reference level 108.8 dBμV Input signal level 98.8 to 58.8 dBμV ±2.1 dB (9 kHz to 2.2 GHz) ±0.9 dB (10 MHz to 2.2 GHz)
With the OPT.15 installed:	Reference level 0 dBm, input signal level -10 to -50 dBm Image suppression OFF ±1.5 dB (9 kHz to 10 MHz) ±0.8 dB (10 MHz to 3.1 GHz) ±1.0 dB (3.1 GHz to 8 GHz)
U3751:	Reference level 0 dBm, input signal level -10 to -50 dBm Image suppression OFF ±1.5 dB (9 kHz to 10 MHz) ±0.8 dB (10 MHz to 3.1 GHz) ±1.0 dB (3.1 GHz to 8 GHz)
Dynamic range	
Displayed average noise level:	Reference level < -45 dBm (63.8 dBμV, with the OPT.15 installed) Resolution bandwidth 100 Hz
U3741	
Pre-Amp OFF:	-123 dBm + 2f (GHz) dB (f < 2.5 GHz) -123 dBm + 2.5f (GHz) dB (f ≥ 2.5 GHz) -12 dBμV + 2f (GHz) dB (f ≤ 2.2 GHz, with the OPT.15 installed)
Pre-Amp ON:	-138 dBm + 3f (GHz) dB -27 dBμV + 3f (GHz) dB (with the OPT.15 installed)
U3751:	Frequency 10 MHz to 8 GHz
Pre-Amp OFF:	-123 dBm + 2f (GHz) dB (f ≤ 3.1 GHz) -122 dBm + 1f (GHz) dB (f ≥ 3 GHz) -138 dBm + 3f (GHz) dB (f ≤ 3.1 GHz)
Pre-Amp ON:	-139 dBm + 1.3f (GHz) dB (f ≥ 3 GHz)
1 dB gain compression	
U3741:	Frequency > 20 MHz
Pre-Amp OFF:	> -5 dBm > 102 dBμV (with the OPT.15 installed)
Pre-Amp ON:	> -25 dBm > 82 dBμV (with the OPT.15 installed)
U3751:	Frequency > 20 MHz
Pre-Amp OFF:	> -8 dBm
Pre-Amp ON:	> -25 dBm
Second harmonic distortion	
U3741:	<-70 dBc (Pre-Amp OFF, Frequency > 20 MHz, Mixer input level -30 dBm (77 dBμV, with the OPT.15 installed))
U3751:	<-70 dBc (Pre-Amp OFF, Frequency > 200 MHz, Mixer input level -40 dBm) <-75 dBc (typ., Pre-Amp OFF, Frequency > 300 MHz, Mixer input level -30 dBm)
Third order intermodulation distortion	
U3741:	< -60dBc (Pre-Amp OFF, Mixer input level -20 dBm (88.8 dBμV, with the OPT.15 installed), Frequency > 10 MHz, 2 signal separation > 200 kHz)
U3751:	< -50 dBc (Pre-Amp OFF, Mixer input level -20 dBm, Frequency 10 MHz to 8 GHz, 2 signal separation > 200 kHz)
Image/multiple/out of band response:	< -60 dBc (Mixer input level -20 dBm (88.8 dBμV, with the OPT.15 installed), Image suppression ON (U3751))
Residual response	
U3741:	< -90 dBm (Frequency > 1 MHz, Pre-Amp OFF) < 21 dBμV (with the OPT.15 installed)
U3751:	< -80 dBm (Frequency 10 MHz to 8 GHz, Pre-Amp OFF)

Inputs/outputs

RF input	
Connector:	N-type female
Impedance:	50 Ω (nominal) 75 Ω (nominal, with the OPT.15 installed)
VSWR:	Input attenuator > 10 dB
U3741:	< 1.5 : 1 < 1.6 : 1 (with the OPT.15 installed)
U3751:	< 1.7 : 1 (Frequency < 3.0 GHz) < 2.0 : 1 (Frequency > 3.0 GHz)
Calibration signal output	
Connector:	BNC female
Impedance:	50 Ω (nominal) 75 Ω (nominal, with the OPT.15 installed)
Frequency:	20 MHz
Level:	-20 dBm
Frequency reference input	
Connector:	BNC female
Impedance:	50 Ω (nominal)
Frequency (MHz):	1, 1.544, 2.048, 5, 10, 12.8, 13, 13.824, 14.4, 15.36, 15.4, 16.8, 19.2, 19.44, 19.6608, 19.68, 19.8, 20, 26
Level:	0 to +16 dBm
External trigger input	
Connector:	BNC female
Impedance:	10 k Ω (nominal), DC coupling
Level:	0 to +5 V
21.4-MHz IF output	
Connector:	BNC female
Impedance:	50 Ω (nominal)
Level:	Approx. mixer input level + 10 dB (at a frequency of 20 MHz)
Battery mount	
Connector:	AntonBauer QR mount
External DC power input	
Connector:	XLR-4
Voltage range:	+11 to +17 V
GPIO:	IEEE-488 bus connector
USB:	USB 1.1
Video output connector:	D-sub15 pin female
LAN connector:	RJ45 type, 10/100 base-T
Audio output:	Small monophonic jack

General specifications

Operating environment range:	Ambient temperature: 0 to + 50°C Humidity: RH 85% or less (no condensation)
Storage environment range:	-20 to +60°C, RH 85% or less
AC power input:	Automatic switching to 100 VAC or 200 VAC 100 V: 100 to 120 V, 50/60 Hz 200 V: 220 to 240 V, 50/60 Hz
DC power input:	DC + 11 V to +17 V
Power consumption:	100 VA or less (AC operation) 70 W or less (DC operation)
Mass	
U3741:	5 kg or less (without option)
U3751:	5.6 kg or less (without option)
External dimensions (W x H x D):	
	Approx. 308 x 175 x 209 mm (not including protruding parts) Approx. 337 x 190 x 307 mm (including the handle and feet)

OPT.20 High-Stability Frequency Reference Source

Frequency reference stability	
Aging rate:	$\pm 2 \times 10^{-8}$ /day $\pm 1 \times 10^{-7}$ /year
Warm-up drift:	$\pm 5 \times 10^{-8}$ (+25°C, 10 minutes after power-on)
Temperature stability:	$\pm 5 \times 10^{-8}$ (0 to +40°C, with reference to 25°C)

OPT.28 EMC Filter

6 dB bandwidth:	200 Hz, 9 kHz, 120 kHz, 1 MHz
Bandwidth accuracy:	< $\pm 10\%$

OPT.70 High-Purity Spectrum Analysis

Frequency span	
Range:	1 kHz to Full, zero span
Accuracy:	< $\pm 1\%$
Resolution bandwidth	
Range:	U3741: 30 Hz to 1 MHz (1 to 3 steps) U3751: 30 Hz to 3 MHz (1 to 3 steps)
Accuracy:	< $\pm 12\%$
Spectrum purity:	
	≤ -98 dBc/Hz (offset 10 kHz, span ≤ 1 MHz) -102 dBc/Hz (Typical)
Displayed average noise level: Reference level < -45 dBm,	
Resolution bandwidth 30 Hz	
U3741:	
Frequency 10 MHz to 3 GHz	
Pre-Amp OFF:	-126 dBm + 2f (GHz) dB (f < 2.5 GHz) -126 dBm + 2.5f (GHz) dB (f ≥ 2.5 GHz)
Pre-Amp ON:	-141 dBm + 3f (GHz) dB
U3751:	
Frequency 10 MHz to 8 GHz	
Pre-Amp OFF:	-126 dBm + 2f (GHz) dB (f ≤ 3.1 GHz) -125 dBm + 1f (GHz) dB (f ≥ 3 GHz)
Pre-Amp ON:	-141 dBm + 3f (GHz) dB (f ≤ 3.1 GHz) -142 dBm + 1.3f (GHz) dB (f ≥ 3 GHz)

OPT.75 75 Ω Tracking Generator

Frequency range:	100 kHz to 2.2 GHz
Frequency offset	
Range:	0 Hz to 1 GHz
Accuracy:	±300 Hz
Resolution:	1 kHz
Output level range:	107 to 47 dBμV (0.5 dB steps)
Output level accuracy:	±0.5 dB (20 MHz, 97 dBμV, +20 to +30°C)
Output level flatness:	Using 20 MHz and 97 dBμV as a reference ±1.0 dB (1 MHz to 1 GHz) ±1.5 dB (100 kHz to 2.2 GHz)
Output level switch error:	Using 20 MHz and 97 dBμV as a reference ±1.0 dB (1 MHz to 1 GHz, 107 to 47 dBμV) ±2.0 dB (1 MHz to 2.2 GHz, 107 to 47 dBμV)
Frequency offset OFF:	±3.0 dB (100 kHz to 2.2 GHz, 107 to 77 dBμV) ±4.0 dB (100 kHz to 2.2 GHz, 76.5 to 47 dBμV)
Frequency offset ON:	±5.0 dB (100 kHz to 2.2 GHz)
Output spurious:	Output level 97 dBμV
Harmonic:	< -15 dBc (100 kHz to 1 MHz) < -20 dBc (1 MHz to 2.2 GHz)
Non-harmonic:	< -20 dBc (Frequency offset OFF)
TG leakage:	< 31 dBμV (Input attenuator 0 dB)
Output impedance:	75 Ω (nominal)
VSWR:	≤ 2.0 : 1 (Output level ≤ 97 dBμV)
Maximum allowable level:	117 dBμV, ±10 VDC

OPT.76 50 Ω Tracking Generator

Frequency range:	100 kHz to 3 GHz
Frequency offset	
Range:	0 Hz to 1 GHz
Accuracy:	±300 Hz
Resolution:	1 kHz
Output level range:	0 to -60 dBm (0.5 dB steps)
Output level accuracy:	±0.5 dB (20 MHz, -10 dBm, +20 to +30°C)
Output level flatness:	Using 20 MHz and -10 dBm as a reference ±1.0 dB (1 MHz to 1 GHz) ±1.5 dB (100 kHz to 3 GHz)
Output level switch error:	Using 20 MHz and -10 dBm as a reference ±1.0 dB (1 MHz to 1 GHz, 0 to -60 dBm) ±2.0 dB (1 MHz to 2.6 GHz, 0 to -60 dBm)
Frequency offset OFF:	±3.0 dB (100 kHz to 3 GHz, 0 to -30 dBm) ±4.0 dB (100 kHz to 3 GHz, -30.5 to -60 dBm)
Frequency offset ON:	±5.0 dB (100 kHz to 3 GHz)
Output spurious:	Output level -10 dBm
Harmonic:	< -15 dBc (100 kHz to 1 MHz) < -20 dBc (1 MHz to 3 GHz)
Non-harmonic:	< -20 dBc (Frequency offset OFF)
TG leakage:	< -80 dBm (Input attenuator 0 dB)
Output impedance:	50 Ω (nominal)
VSWR:	≤ 2.0 : 1 (Output level ≤ -10 dBm)
Maximum allowable level:	+10 dBm, ±10 VDC

Ordering information

Main unit	
Spectrum analyzer:	U3741 U3751
Accessories	
Operating manual (CD):	BU37005
Power cable:	A01412
Input cable:	A01037-0300
With the OPT.15 installed:	D3C0025-S-SA
N-BNC adapter:	JUG-201A/U
With the OPT.15 installed:	BA-A165
NC-F adapter (with the OPT.15 installed):	NCP-NFJ
Ferrite core:	ESD-SR-120
Options	
75 Ω Input Impedance:	OPT.15
High-Stability Frequency Reference Source:	OPT.20
EMC Filter:	OPT.28
High-Purity Spectrum Analysis:	OPT.70
75 Ω Tracking Generator:	OPT.75
50 Ω Tracking Generator:	OPT.76
Accessories	
Japanese operating manual (printed manual):	JU37005
English operating manual (printed manual):	EU37005
Battery pack:	A870008
Charger:	A870009
75 Ω input impedance converter:	ZT-130NC
DC power cable:	A114020
Carrying bag:	A129001
Transit case:	A129002
Rack mount kit (JIS):	A122003
Rack mount kit (EIA):	A124004

Note on accessories:

The operating manual on the CD is supplied as standard.
The printed version of the operating manual is offered as an accessory.

*Please refer to product manual for complete system specifications.
Specifications may change without notification.*

ADVANTEST[®]

<http://www.advantest.co.jp>

ADVANTEST CORPORATION
Shin-Marunouchi Center Building, 1-6-2 Marunouchi, Chiyoda-ku, Tokyo 100-0005, Japan Phone: +81-3-3214-7500